

Zing

PRODUCT CATALOG

SUPINE TO PRONE IN ONE MOTION



EasyStand 

Zing

MPS, Supine, MPS Tilt Table(TT),
Supine Tilt Table(TT), Vertical, & Prone

The Zing line of multi and single position standers were designed to fit the widest range of children and accommodate positioning challenges few others can. The Zing line features independent leg abduction up to 30 degrees on each model. The units can be configured simply, with padded strapping system to ease transfers and aid multi-user environments. But when required, individual positioning and support components can be added.



Zing Vertical

The Zing

True Multi-Position Stander

- The MPS base allows three positions without changing pads, flipping foot plates or moving the tray
- Provides a smooth transition from a flat-to-load transfer to supine, vertical and 20 degrees prone
- Frame will only go supine and upright with Prone Position Lockout engaged

True Hip Pivot Leg Abduction

- Pivots at the hips for proper leg alignment in hips, knees and feet
- Feet maintain angle with the rest of the legs – no wedges needed
- Up to 30 degrees of abduction per leg
- Promotes musculoskeletal development for infants, toddlers and kids

Plenty of Growth

- Size 1 fits children from infancy to 44"
- Can easily grow with the child and adapt to their changing needs
- 70 pound weight capacity

Multi-Use Tray

- The MPS, Supine, MPS TT and Supine TT feature a multi-use tray that is angle adjustable and swings away
- Tray can remain attached during transfers
- More activities are possible by swinging tray away during standing therapy

Advantage

Accommodating Contractures

- No special modifications are needed to accommodate children with contractures
- Using the multi-adjustable foot plates, multi-adjustable knee pads, and the independent calf pads, it is possible to adjust for contractures in one or both sides

Hygienic Covers

- Available for the pelvic, upper body, lateral, head and tray areas
- Easy to wash
- Especially beneficial if stander is used during feeding
- Keeps stander from getting soiled

Unique Lift Mechanisms

- Dual controls are available allowing angle adjustment by foot pedal or hand control
- Gas Spring Lockout prevents an inadvertent change of position, especially important when around other children

Remarkably Modular

- Can be configured as a simple stander or fit a child with the most complex needs
- Designed to grow with the child – options can be added as needed
- Great for a multi-user facility or school



Zing MPS



Zing Prone

Zing

MPS, Supine, MPS Tilt Table(TT),
Supine Tilt Table(TT), Vertical, & Prone

SUPINE TO PRONE



Supine Lying



Supine



Vertical



Prone

Health Benefits

- Improve/maintain range of motion
- Decrease joint/muscle contractures
- Management of atrophy in the trunk and leg muscles
- Improve strength to trunk and lower extremities
- Decrease muscle spasms
- Promote proper muscle skeleton development
- Improve/maintain bone integrity/skeletal development
- Lessen/manage the progression of scoliosis
- Manage pressure (ulcers) through changing positions
- Improve bowel function and regularity
- Aid in kidney and bladder functions
- Strengthen cardiovascular system and build endurance
- Improve circulation
- Reduce swelling in lower extremities

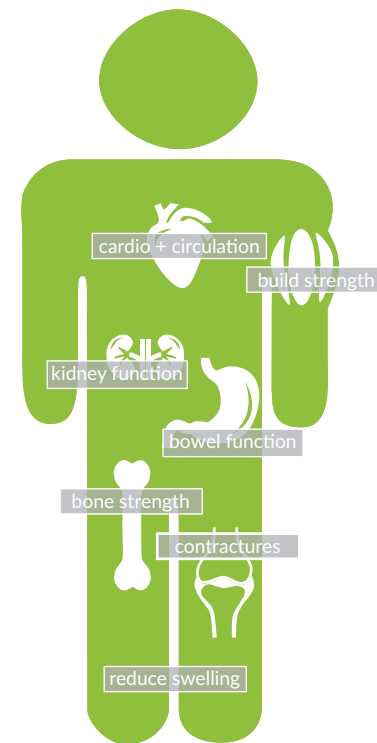

Hygienic Cover Patterns



RAINBOW UNICORN



SEA CREATURES



FANCY PANTS ELEPHANTS



SPACE RACE



ALL SMILES ANIMALS

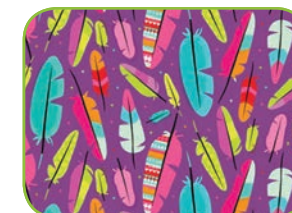

FEATHERS IN FLIGHT

Frame Colors



GREEN



PURPLE

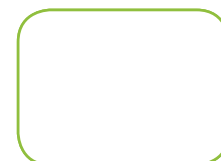

WHITE



ORANGE



Zing MPS



Zing Prone



Zing MPS TT

Zing

MPS, Supine, MPS Tilt Table(TT),
Supine Tilt Table(TT), Vertical, & Prone

SPECIFICATIONS

additional specifications at easystand.com



Zing Supine

	MPS (Multi-Position Stander)	Supine	MPS Tilt Table (TT)	Supine Tilt Table (TT)	Vertical	Prone
	The Zing MPS is the only multi-position stander that can seamlessly transition from supine to prone without having to transfer the child out and reposition foot plates, pads or trays.	The Zing Supine features a comfortable 32" transfer height and provides all the positioning and support features of the MPS.	The Zing MPS TT is identical to the MPS from a positioning standpoint, but features larger, wider support pads and options for padded strapping, that can simplify transferring and securing children.	The Zing Supine TT features the larger pads and padded strapping options of the MPS TT and positioning from flat to load supine to vertical.	The Zing Vertical is a single position stander that features a Padded Quick Strap to ease upright transfers. It's also one of the only vertical standers to offer anatomically correct independent leg abduction.	The Zing Prone is a single position stander but is one of the few to offer a flat-to-load transfer position at a comfortable height of 32". Prone positioning from 0-90 degrees.
Weight Limit	70 lbs. (32kg)	70 lbs. (32kg)	70 lbs. (32kg)	70 lbs. (32kg)	70 lbs. (32kg)	70 lbs. (32kg)
Height Range	up to 44" (112cm)	up to 44" (112cm)	up to 44" (112cm)	up to 44" (112cm)	up to 44" (112cm)	up to 44" (112cm)
Transfer Height	32"(81cm)	32" (81cm)	32" (81cm)	32" (81cm)	n/a	32" (81cm)
Pelvic Support to Foot Plate Range	7"-22" (18-56cm)	7"-22" (18-56cm)	7"-22" (18-56cm)	7"-22" (18-56cm)	7"-22" (18-56cm)	7"-22" (18-56cm)
Upper Body Support Height Range	4" (10cm)	4" (10cm)	4" (10cm)	4" (10cm)	4" (10cm)	4" (10cm)
Knee Pad Depth Range	5" (13cm)	5" (13cm)	5" (13cm)	5" (13cm)	5" (13cm)	5" (13cm)
Weight of Basic Unit	55 lbs (25kg)	55 lbs (25kg)	55 lbs (25kg)	55 lbs (25kg)	55 lbs (25kg)	55 lbs (25kg)
Frame Footprint	20"x28" (51x71cm)	20"x28" (51x71cm)	20"x28" (51x71cm)	20"x28" (51x71cm)	20"x28" (51x71cm)	20"x28" (51x71cm)
30° Independent Leg Abduction	Available	Available	Available	Available	Available	Available
Supine	0-90°	0-90°	0-90°	0-90°	n/a	n/a
Prone	0°-20°	n/a	0°-20°	n/a	n/a	0°-90°
HCPCS	E0641	E0638	E0641	E0638	E0638	E0638
Positions	Supine, Vertical, Prone	Supine, Vertical	Supine, Vertical, Prone	Supine, Vertical	Vertical	Vertical, Prone
Tray	Adjustable, Swing-Away	Adjustable, Swing-Away	Adjustable, Swing-Away	Adjustable, Swing-Away	Adjustable	Adjustable
Support	Individual Positioning Components, Padded Strapping	Individual Positioning Components, Padded Strapping	Individual Positioning Components, Padded Strapping	Individual Positioning Components, Padded Strapping	Individual Positioning Components, Padded Strapping	Individual Positioning Components, Padded Strapping
Dual Control	Available	Available	Available	Available	n/a	Available
Gas Spring Lockout	Available	Available	Available	Available	n/a	Available
Transfer Aid	Flat-to-Load	Flat-to-Load	Flat-to-Load	Flat-to-Load	n/a	Flat-to-Load
Tool Free Adjustment	Yes	Yes	Yes	Yes	Yes	Yes



Zing MPS TT

FITTING THE ZING

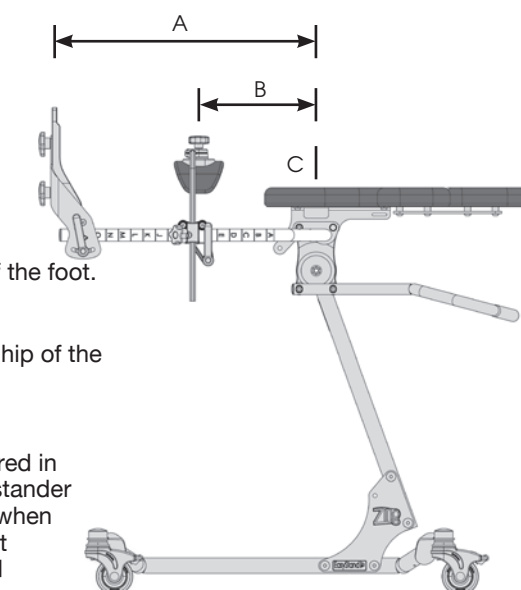

Foot Plate Height (A):
Measure the distance from the hip of the user to the bottom of the foot.

Knee Pad Height (B):
Measure the distance from the hip of the user to center of the knee.

Centering the Hip (C):
The user's hip should be centered in line with the pivot point of the stander ensuring proper hip alignment when using abduction, adjust support components up or down based hip position.

Zing MPS (Multi-Position Stander)

Options

up to 44"
(112cm)



70 lbs
(32 kg)

The MPS (multi-position stander) base includes:

- Four Swivel Locking Casters
- Foot Operated Gas Spring
- Mast Receiver with Prone Position Lockout



PA5520 Zing MPS Base

Comes with four swivel locking casters, foot operated gas spring, mast receiver with prone position lockout.



PA5624, PA5626, PA5628 Multi-Adjustable Foot Plates

Foot plates are adjustable forward/aft +/- .75" (2cm) +extra 1.5" (3.8cm), plantar/dorsi +/- 20°, toe-in/toe-out, swivel 30° left/right, and in height. Foot holder sizes: PA5624-6"Lx3"W (15x8cm), PA5626-7.75"Lx3.25"W (20x8cm), PA5628-9.75"Lx4"W (25x10cm).



PA5562 Planar Pads-5"Hx7"W PA5564 Planar Pads-5"Hx9"W

Cushioned pad covered with Neoprene®. Pad sizes: PA5562-5"Hx7"W (13x18cm), PA5564-5"Hx9"W (13x23cm).



PA5530 Mast

Mast is the base for positioning options including foot plates, knee supports, pelvic supports, upper body supports and head supports.



PA5540, PA5542, PA5544 Foot Holders for Platform Foot Plate

Use with the platform foot plate, gives added positioning of users feet. Foot holder sizes: PA5540-6"Lx3"W (15x8cm), PA5542-7.75"Lx3.25"W (20x8cm), PA5544-9.75"Lx4"W (25x10cm).



PA5566 Form to Fit Pads-5"Hx10"W PA5570 Form to Fit Pads-5"Hx12"W

Form to fit pad can be custom fitted to the user. Pad sizes: PA5566-5"Hx10" (13x25cm) PA5570-5"Hx12"W (13x30cm). Not recommended with leg abduction mast.



PA5532 Mast with Leg Abduction

Mast is the base for support and positioning components and allows for 0-30° of independent leg abduction. Multi-adjustable knee pads and multi-adjustable foot plates required to do leg abduction.



PA5546 Secure Foot Straps-8"L PT50082 Secure Foot Straps-10"L

Velcro® and D-ring adjustment holds feet securely in place at ankles and toes with multiple attachment slots for proper foot positioning. Straps measured in length over top of foot, with approximately 1.5" (4cm) of Velcro® overlap.



PA5574 Hip Supports

Keeps the hips in symmetrical alignment. Adjustable from 6"-10" (15-25cm) with fore/aft 4" (10cm). Pad size is 3.5"x3.5" (9x9cm). For planar pads only.



PA5612 Dual Control

Allows both foot and hand control of the gas spring lift. Must order push handle PA5594.



PA5548 Foot Straps-8"L PT50080 Foot Straps-10"L

Velcro® and D-ring adjustment holds feet in alignment with multiple attachment slots for proper foot positioning. Straps measured in length over top of foot, with approximately 1.5" (4cm) of Velcro® overlap.



PA3011 Positioning Belt

2" (5cm) wide belt has a D-Ring Velcro closure, provides hip stability for user. Fits circumference up to 24" (61cm).



PA5614 Gas Spring Lockout

Locks gas spring in any position from lying down to fully upright and prone positions.



PA5550 Calf/Knee Pad with Strap

4"x10" (10x25cm) pad attached to a 2" (5cm) belt with a D-Ring Velcro closure, provides calf/knee stability for user. Fits circumference up to 24" (61cm). Gives support from the back of the calf/knee. Adjustable in height and fore/aft.

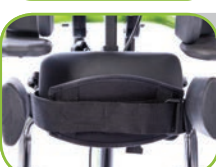

PA5610 Padded Positioning Strap

5"x8" (13x20cm) pad attached to a 2" (5cm) belt. Fits circumference up to 24" (61cm).



PA5608 Directional Locking Caster

Great for transporting stander. Directionally locks one caster while leaving the other three free to swivel.



PA5556 Multi-Adjustable Knee Pads-4"Hx3.5"W PA5558 Multi-Adjustable Knee Pads-4"Hx4"W

Multi-adjustable knee pads are adjustable in swivel, height +/- .75" (2cm), PA5556 width 4"-9" (10-23cm) and PA5558 4.5"-9" (11-23cm). With a depth range of 5" (13cm).

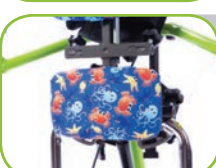

PA3028, PA3029 Hygienic Covers

Washable slip on cover available in six different patterns. For planar pads PA5562 and PA5564.



PA5536 Platform Foot Plate

Adjustable in height. Foot holders and foot straps can be added for more positioning of the feet.



PA5560 Multi-Adjustable Calf Pads 3.5" PA5678 Multi-Adjustable Calf Pads 4.5"

Great for adapting to knee contractures. Gives support from the back of the calf. Adjustable up and down with knee pad and fore/aft 4" (10cm) independently. Must order multi-adjustable knee pads.



PA3030, PA3032 Hygienic Covers

Washable slip on cover available in six different patterns. For form to fit pads PA5566 and PA5570.



PA5562 Planar Pads-5"Hx7"W
PA5564 Planar Pads-5"Hx9"W
Cushioned pad covered with Neoprene®. Pad sizes: PA5562-5"Hx7"W (13x18cm), PA5564-5"Hx9"W (13x23cm).



PA3028, PA3029, PA3045, PA3046 Hygienic Covers
Washable slip on cover available in six different patterns. For planar pads PA5562, PA5564, PA5566, PA5568.



PA5602 Clear Swing Away Tray-11"Lx19"W
Swing-away tray is accessible in all positions and provides anterior support as user moves from supine to upright and prone positions. Adjustable in depth, height and tray angle. Tray size is 11"Lx19"W (28x48cm).



PA5616 Planar Pads-7"Hx7"W
PA5618 Planar Pads-7"Hx9"W
Cushioned pad covered with Neoprene®. Pad sizes: PA5616-7"Hx7"W (18x18cm), PA5618-7"Hx9"W (18x23cm).



PA3031, PA3033, PA3047, PA3048 Hygienic Covers
Washable slip on cover available in six different patterns. For form to fit pads PA5568, PA5572, PA5620, PA5622.



PA5604 Forearm Wings-Black Molded Tray
Wings give additional area to rest arms when in standing position.

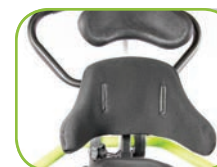

PA5568 Form to Fit Pads-5"Hx10"W
PA5620 Form to Fit Pads-7"Hx10"W
Form to fit pad with built in lateral support that can be custom fitted to the user. Pad size for PA5568 is 5"Hx10"W (13x25cm) and PA5620 is 7"Hx10"W (18x25cm).



PA3039 Hygienic Covers for Lateral Supports
Washable slip on cover available in six different patterns. For lateral supports PA5576.



PA5606 Forearm Wings-Clear Acrylic Tray
Wings give additional area to rest arms when in standing position.



PA5572 Form to Fit Pads-5"Hx12"W
PA5622 Form to Fit Pads-7"Hx12"W
Form to fit pad with built in lateral support that can be custom fitted to the user. Pad size for PA5572 is 5"Hx12"W (13x30cm) and PA5622 is 7"Hx12"W (18x30cm).



PY5626 Head Support-5"Hx8"W
PY5628 Head Support-6"Hx10"W
Cushion size is 5"Hx8"W (13x20cm), 6"Hx10"W (15x25cm). Depth range is +1" to -2.75" (+2 to -7cm) from backrest. Maximum height from seat is 24" (61cm).



PA3038 Hygienic Padded Cover
Washable slip on cover is padded and available in six different patterns.



PA5576 Lateral Supports

Keeps the upper torso in symmetrical alignment. Adjustable from 7-11" (18-28cm) with a 3.5" (9cm) height range. Pad size is 3.5"Hx3.5"W (9x9cm). For planar pads only.



PA5586 Form to Fit Headrest

Cushion size 5"Hx10"W (13x25cm). Depth range is -2.5" (6cm) to +1.5" (4cm) from backrest. Maximum height from top of upper body pad is 8" (20cm).



PNG50042 Hand Grips

Provides additional arm and hand support and alignment. Easily movable for precise arm positioning. Attaches with suction cups. Clear tray required.



PA5578 Lateral Supports with Elbow Stop
Works as a lateral support and elbow rest. Great for the supine position. For planar pads only.



PA3035, PA3036 Hygienic Covers

Washable slip on cover available in six different patterns. For PY5626 and PY5628.



PA5594 Push Handle

Makes pushing the stander easier for the caregiver and also aids in lifting and lowering the child. Required for dual control.



PA5580 Lateral Supports w/Elbow Stop/Arm Rest
Works as a lateral support, elbow rest and armrest. Great for the supine, upright and prone position. For planar pads only.



PA3037 Hygienic Cover

Washable slip on cover available in six different patterns. For PA5586.



P80809 Tool Pouch

Holds the assembly tools provided with the stander. Attaches to unit with Velcro® straps.



PA5630 Elbow Stop with Arm Rest

Great for loading and bringing to upright. Works with both planar and form to fit upper body supports. For planar and form to fit pads.



PA5596 Black Molded Tray-11"Lx19"W

Tray is accessible in all positions and provides anterior support as user moves from supine to upright and prone positions. Adjustable in depth and height. Tray size is 11"Lx19"W (28x48cm).



P80246 Angle Locator

Helps therapists monitor standing progress. Attaches to the mast. Can be used on leg abduction.



PT50086 X-Style Chest Vest-9.5"Lx9"W
PT50088 X-Style Chest Vest-11"Lx9.5"W
Neoprene® with camlock adjustment provides anterior trunk support for child.



PA5600 Black Molded Swing-Away Tray-11"Lx19"W

Swing-away tray is accessible in all positions and provides anterior support as user moves from supine to upright and prone positions. Adjustable in depth, height and tray angle. Tray size is 11"Lx19"W (28x48cm).

Zing Supine Options

up to 44"
(112cm)



The Supine base includes:

- Four Swivel Locking Casters
- Foot Operated Gas Spring
- Mast Receiver

PA5522 Zing Supine Base
Comes with four swivel locking casters, foot operated gas spring and a mast receiver.

PA5624, PA5626, PA5628 Multi-Adjustable Foot Plates
Foot plates are adjustable forward/aft +/- .75" (2cm) +extra 1.5" (3.8cm), plantar/dorsi +/- 20°, toe-in/toe-out, swivel 30° left/right, and in height. Foot holder sizes: PA5624-6"Lx3"W (15x8cm), PA5626-7.75"Lx3.25"W (20x8cm), PA5628-9.75"Lx4"W (25x10cm).

**PA5562 Planar Pads-5"Hx7"W
PA5564 Planar Pads-5"Hx9"W**
Cushioned pad covered with Neoprene®. Pad sizes: PA5562-5"Hx7"W (13x18cm), PA5564-5"Hx9"W (13x23cm).

PA5530 Mast
Mast is the base for positioning options including foot plates, knee supports, pelvic supports, upper body supports and head supports.

PA5540, PA5542, PA5544 Foot Holders for Platform Foot Plate
Use with the platform foot plate, gives added positioning of users feet. Foot holder sizes: PA5540-6"Lx3"W (15x8cm), PA5542-7.75"Lx3.25"W (20x8cm), PA5544-9.75"Lx4"W (25x10cm).

**PA5566 Form to Fit Pads-5"Hx10"W
PA5570 Form to Fit Pads-5"Hx12"W**
Form to fit pad can be custom fitted to the user. Pad sizes: PA5566-5"Hx10" (13x25cm) PA5570-5"Hx12"W (13x30cm). Not recommended with leg abduction mast.

PA5532 Mast with Leg Abduction
Mast is the base for support and positioning components and allows for 0-30° of independent leg abduction. Multi-adjustable knee pads and multi-adjustable foot plates required to do leg abduction.

**PA5546 Secure Foot Straps-8"L
PT50082 Secure Foot Straps-10"L**
Velcro® and D-ring adjustment holds feet securely in place at ankles and toes with multiple attachment slots for proper foot positioning. Straps measured in length over top of foot, with approximately 1.5" (4cm) of Velcro® overlap.

PA5574 Hip Supports
Keeps the hips in symmetrical alignment. Adjustable from 6"-10" (15-25cm) with fore/aft 4" (10cm). Pad size is 3.5"x3.5" (9x9cm). For planar pads only.

PA5612 Dual Control
Allows both foot and hand control of the gas spring lift. Must order push handle PA5594.

**PA5548 Foot Straps-8"L
PT50080 Foot Straps-10"L**
Velcro® and D-ring adjustment holds feet in alignment with multiple attachment slots for proper foot positioning. Straps measured in length over top of foot, with approximately 1.5" (4cm) of Velcro® overlap.

PA3011 Positioning Belt
2" (5cm) wide belt has a D-Ring Velcro closure, provides hip stability for user. Fits circumference up to 24" (61cm).

PA5614 Gas Spring Lockout
Locks gas spring in any position from lying down to fully upright and supine positions.

PA5550 Calf/Knee Pad with Strap
4"x10" (10x25cm) pad attached to a 2" (5cm) belt with a D-Ring Velcro closure, provides calf/knee stability for user. Fits circumference up to 24" (61cm). Gives support from the back of the calf/knee. Adjustable in height and fore/aft.

PA5610 Padded Positioning Strap
5"x8" (13x20cm) pad attached to a 2" (5cm) belt. Fits circumference up to 24" (61cm).

PA5608 Directional Locking Caster
Great for transporting stander. Directionally locks one caster while leaving the other three free to swivel.

**PA5556 Multi-Adjustable Knee Pads-4"Hx3.5"W
PA5558 Multi-Adjustable Knee Pads-4"Hx4"W**
Multi-adjustable knee pads are adjustable in swivel, height +/- .75" (2cm), PA5556 width 4"-9" (10-23cm) and PA5558 4.5"-9" (11-23cm). With a depth range of 5" (13cm).

PA3028, PA3029 Hygienic Covers
Washable slip on cover available in six different patterns. For planar pads PA5562 and PA5564.

PA5536 Platform Foot Plate
Adjustable in height. Foot holders and foot straps can be added for more positioning of the feet.

**PA5560 Multi-Adjustable Calf Pads 3.5"
PA5678 Multi-Adjustable Calf Pads 4.5"**
Great for adapting to knee contractures. Gives support from the back of the calf. Adjustable up and down with knee pad and fore/aft 4" (10cm) independently. Must order multi-adjustable knee pads.

PA3030, PA3032 Hygienic Covers
Washable slip on cover available in six different patterns. For form to fit pads PA5566 and PA5570.

**PA5562 Planar Pads-5"Hx7"W
PA5564 Planar Pads-5"Hx9"W**
Cushioned pad covered with Neoprene®. Pad sizes: PA5562-5"Hx7"W (13x18cm), PA5564-5"Hx9"W (13x23cm).

PA3028, PA3029, PA3045, PA3046 Hygienic Covers
Washable slip on cover available in six different patterns. For planar pads PA5562, PA5564, PA5566, PA5568.

PA5602 Clear Swing Away Tray-11"Lx19"W
Swing-away tray is accessible in all positions and provides anterior support as user moves from supine to upright and prone positions. Adjustable in depth, height and tray angle. Tray size is 11"Lx19"W (28x48cm).

**PA5616 Planar Pads-7"Hx7"W
PA5618 Planar Pads-7"Hx9"W**
Cushioned pad covered with Neoprene®. Pad sizes: PA5616-7"Hx7"W (18x18cm), PA5618-7"Hx9"W (18x23cm).

PA3031, PA3033, PA3047, PA3048 Hygienic Covers
Washable slip on cover available in six different patterns. For form to fit pads PA5568, PA5572, PA5620, PA5622.

PA5604 Forearm Wings-Black Molded Tray
Wings give additional area to rest arms when in standing position.

**PA5568 Form to Fit Pads-5"Hx10"W
PA5620 Form to Fit Pads-7"Hx10"W**
Form to fit pad with built in lateral support that can be custom fitted to the user. Pad size for PA5568 is 5"Hx10"W (13x25cm) and PA5620 is 7"Hx10"W (18x25cm).

PA3039 Hygienic Covers for Lateral Supports
Washable slip on cover available in six different patterns. For lateral supports PA5576.

PA5606 Forearm Wings-Clear Acrylic Tray
Wings give additional area to rest arms when in standing position.

**PA5572 Form to Fit Pads-5"Hx12"W
PA5622 Form to Fit Pads-7"Hx12"W**
Form to fit pad with built in lateral support that can be custom fitted to the user. Pad size for PA5572 is 5"Hx12"W (13x30cm) and PA5622 is 7"Hx12"W (18x30cm).

**PY5626 Head Support-5"Hx8"W
PY5628 Head Support-6"Hx10"W**
Cushion size is 5"Hx8"W (13x20cm), 6"Hx10"W (15x25cm). Depth range is +1" to -2.75" (+2 to -7cm) from backrest. Maximum height from seat is 24" (61cm).

PA3038 Hygienic Padded Cover
Washable slip on cover is padded and available in six different patterns.

PA5576 Lateral Supports
Keeps the upper torso in symmetrical alignment. Adjustable from 7-11" (18-28cm) with a 3.5" (9cm) height range. Pad size is 3.5"Hx3.5"W (9x9cm). For planar pads only.

PA5586 Form to Fit Headrest
Cushion size 5"Hx10"W (13x25cm). Depth range is -2.5" (6cm) to +1.5" (4cm) from backrest. Maximum height from top of upper body pad is 8" (20cm).

PNG50042 Hand Grips
Provides additional arm and hand support and alignment. Easily movable for precise arm positioning. Attaches with suction cups. Clear tray required.

PA5578 Lateral Supports with Elbow Stop
Works as a lateral support and elbow rest. Great for the supine position. For planar pads only.

PA3035, PA3036 Hygienic Covers
Washable slip on cover available in six different patterns. For PY5626 and PY5628.

PA5594 Push Handle
Makes pushing the stander easier for the caregiver and also aids in lifting and lowering the child. Required for dual control.

PA5580 Lateral Supports w/Elbow Stop/Arm Rest
Works as a lateral support, elbow rest and armrest. Great for the supine, upright and prone position. For planar pads only.

PA3037 Hygienic Cover
Washable slip on cover available in six different patterns. For PA5586.

P80809 Tool Pouch
Holds the assembly tools provided with the stander. Attaches to unit with Velcro® straps.

PA5630 Elbow Stop with Arm Rest
Great for loading and bringing to upright. Works with both planar and form to fit upper body supports. For planar and form to fit pads.

PA5596 Black Molded Tray-11"Lx19"W
Tray is accessible in all positions and provides anterior support as user moves from supine to upright and prone positions. Adjustable in depth and height. Tray size is 11"Lx19"W (28x48cm).

P80246 Angle Locator
Helps therapists monitor standing progress. Attaches to the mast. Can be used on leg abduction.

**PT50086 X-Style Chest Vest-9.5"Lx9"W
PT50088 X-Style Chest Vest-11"Lx9.5"W**
Neoprene® with camlock adjustment provides anterior trunk support for child.

PA5600 Black Molded Swing-Away Tray-11"Lx19"W
Swing-away tray is accessible in all positions and provides anterior support as user moves from supine to upright and prone positions. Adjustable in depth, height and tray angle. Tray size is 11"Lx19"W (28x48cm).

Zing MPS Tilt Table (TT)

Options

up to 44"
(112cm)



The MPS (multi-position stander) base includes:

- Four Swivel Locking Casters
- Foot Operated Gas Spring
- Mast Receiver with Prone Position Lockout

 <p>PA5520 Zing MPS TT Base Comes with four swivel locking casters, foot operated gas spring, mast receiver with prone position lockout.</p>	 <p>PA5624, PA5626, PA5628 Multi-Adjustable Foot Plates Foot plates are adjustable forward/aft +/- .75" (2cm) +extra 1.5" (3.8cm), plantar/dorsi +/- 20°, toe-in/toe-out, swivel 30° left/right, and in height. Foot holder sizes: PA5624-6"Lx3"W (15x8cm), PA5626-7.75"Lx3.25"W (20x8cm), PA5628-9.75"Lx4"W (25x10cm).</p>	 <p>PA5666, PA5668, PA5670 Knee Strap 4"x6" (10x15cm) pad attached to a 1.5" (4cm) belt. Fits circumference up to 15" (38cm). Adjustable in height. For leg supports PA5644, PA5646, PA5648.</p>
 <p>PA5632 Mast Mast is the base for support and positioning components.</p>	 <p>PA5540, PA5542, PA5544 Foot Holders Use with the platform foot plate, gives added positioning of users feet. Foot holder sizes: PA5540-6"Lx3"W (15x8cm), PA5542-7.75"Lx3.25"W (20x8cm), PA5544-9.75"Lx4"W (25x10cm).</p>	 <p>PA5556 Multi-Adjustable Knee Pads-4"Hx3.5"W PA5558 Multi-Adjustable Knee Pads-4"Hx4"W Multi-adjustable knee pads are adjustable in swivel, height +/- .75" (2cm), PA5556 width 4"-9" (10x23cm) and PA5558 4.5"-9" (11x23cm). With a depth range of 5" (13cm).</p>
 <p>PA5634 Mast with Leg Abduction Mast is the base for support and positioning components and allows for 0-30° of independent leg abduction. Multi-adjustable knee pads and multi-adjustable foot plates required to do leg abduction.</p>	 <p>PA5546 Secure Foot Straps-8"L PT50082 Secure Foot Straps-10"L Velcro® and D-ring adjustment holds feet securely in place at ankles and toes with multiple attachment slots for proper foot positioning. Straps measured in length over top of foot, with approximately 1.5" (4cm) of Velcro® overlap.</p>	 <p>PA5560 Multi-Adjustable Calf Pads 3.5" PA5678 Multi-Adjustable Calf Pads 4.5" Great for adapting to knee contractures. Gives support from the back of the calf. Adjustable up and down with knee pad and fore/aft -1"-4" (-2.5-10cm) independently. Must order multi-adjustable knee pads.</p>
 <p>PA5612 Dual Control Allows both foot and hand control of the gas spring lift. Must order push handle PA5594.</p>	 <p>PA5548 Foot Straps-8"L PT50080 Foot Straps-10"L Velcro® and D-ring adjustment holds feet in alignment with multiple attachment slots for proper foot positioning. Straps measured in length over top of foot, with approximately 1.5" (4cm) of Velcro® overlap.</p>	 <p>PA5638, PA5640, PA5642 Planar Pad Cushioned pad covered with Neoprene®. Pad sizes: PA5638-14"Hx14"W (36x36cm) PA5640-16"Hx14"W (41x36cm) PA5642-18"Hx14"W (46x36cm)</p>
 <p>PA5614 Gas Spring Lockout Locks gas spring in any position from lying down to fully upright and prone positions.</p>	 <p>PA5644, PA5646, PA5648 Leg Support Planar Pads Cushioned Neoprene® pad for leg support. Pad sizes: PA5644-4"Hx6"W (10x15cm) PA5646-6"Hx6"W (15x15cm) PA5648-8"Hx6"W (20x15cm)</p>	 <p>PA3063, PA3064, PA3065 Hygienic Covers Washable slip on cover available in six different patterns. For planar pads PA5638, PA5640, PA5642.</p>
 <p>PA5608 Directional Locking Caster Great for transporting stander. Directionally locks one caster while leaving the other three free to swivel.</p>	 <p>PA5660, PA5662, PA5664 Hygienic Covers Washable slip on cover available in six different patterns. For planar pads PA5644, PA5646, PA5648.</p>	 <p>PA5636 Hip Supports Keeps the hips in symmetrical alignment. Adjustable from 6"-10" (15-25cm) with fore/aft 4" (10cm). Pad size is 3.5"x3.5" (9x9cm).</p>
 <p>PA5536 Platform Foot Plate Adjustable in height. Foot holders and foot straps can be added for more positioning of the feet.</p>	 <p>PA5550 Calf/Knee Pad with Strap 4"x10" (10x25cm) pad attached to a 2" (5cm) belt with a D-Ring Velcro closure, provides calf/knee stability for user. Fits circumference up to 24" (61cm). Gives support from the back of the calf/knee. Adjustable in height and fore/aft.</p>	 <p>PA3062 Positioning Strap 2" (5cm) wide belt has a D-Ring Velcro closure, provides hip stability for user. Fits circumference up to 24" (61cm).</p>

 <p>PA5672 Pelvic Padded Positioning Strap 5"x8" (13x20cm) pad attached to a 2" (5cm) belt. Fits circumference up to 24" (61cm).</p>	 <p>PA3066, PA3035, PA3036, PA3037 Hygienic Covers Washable slip on cover available in six different patterns. For head supports PA5650, PY5626, PY5628, PA5586.</p>	 <p>P80809 Tool Pouch Holds the assembly tools provided with the stander. Attaches to unit with Velcro® straps.</p>
 <p>PA5652 Lateral Supports-4"-8"Range PA5654 Lateral Supports-7"-11"Range Keeps the upper torso in symmetrical alignment. PA5652 Adjustable from 4"-8" (10-20cm), PA5654 Adjustable from 7"-11" (18-28cm) with a 3.5" (9cm) height range. Pad size is 3.5"Hx3.5"W (9x9cm).</p>	 <p>PA5596 Black Molded Tray-11"Lx19"W Tray is accessible in all positions and provides anterior support as user moves from supine to upright and prone positions. Adjustable in depth and height. Tray size is 11"Lx19"W (28x48cm).</p>	 <p>P80246 Angle Locator Helps therapists monitor standing progress. Attaches to the mast. Can be used on leg abduction.</p>
 <p>PA5674 Upper Body Padded Positioning Strap 5"x8" (13x20cm) pad attached to a 2" (5cm) belt. Fits circumference up to 24" (61cm).</p>	 <p>PA5600 Black Molded Swing-Away Tray-11"Lx19"W Swing-away tray is accessible in all positions and provides anterior support as user moves from supine to upright and prone positions. Adjustable in depth, height and tray angle. Tray size is 11"Lx19"W (28x48cm).</p>	
 <p>PT50086 X-Style Chest Vest-9.5"Lx9"W PT50088 X-Style Chest Vest-11"Lx9.5"W Neoprene® with camlock adjustment provides anterior trunk support for child.</p>	 <p>PA5602 Clear Swing Away Tray-11"Lx19"W Swing-away tray is accessible in all positions and provides anterior support as user moves from supine to upright and prone positions. Adjustable in depth, height and tray angle. Tray size is 11"Lx19"W (28x48cm).</p>	
 <p>PA3039 Hygienic Covers for Lateral Supports Washable slip on cover available in six different patterns. For lateral supports PA5652 and PA5654.</p>	 <p>PA5604 Forearm Wings-Black Molded Tray Wings give additional area to rest arms when in standing position.</p>	
 <p>PA5650 Planar Head Support Cushioned Neoprene® pad for head support. Pad size 8"Hx8.5"W (21x22cm).</p>	 <p>PA5606 Forearm Wings-Clear Acrylic Tray Wings give additional area to rest arms when in standing position.</p>	
 <p>PY5626 Head Support-5"Hx8"W PY5628 Head Support-6"Hx10"W Cushion size is 5"Hx8"W (13x20cm), 6"Hx10"W (15x25cm). Depth range is +1" to -2.75" (+2 to -7cm) from backrest. Maximum height from seat is 24" (61cm).</p>	 <p>PA3038 Hygienic Padded Tray Cover Washable slip on cover for tray is padded and available in six different patterns.</p>	
 <p>PA5586 Form to Fit Headrest Cushion size 5"Hx10"W (13x25cm). Depth range is -2.5" (6cm) to +1.5" (4cm) from backrest. Maximum height from top of upper body pad is 8" (20cm).</p>	 <p>PNG50042 Hand Grips Provides additional arm and hand support and alignment. Easily movable for precise arm positioning. Attaches with suction cups. Clear tray required.</p>	
 <p>PA5676 Headrest Mounting Bracket For use when mounting an after market head support.</p>	 <p>PA5594 Push Handle Makes pushing the stander easier for the caregiver and also aids in lifting and lowering the child. Required for dual control.</p>	

Zing Supine Tilt Table (TT)

Options

up to 44"
(112cm)



The Supine base includes:

- Four Swivel Locking Casters
- Foot Operated Gas Spring
- Mast Receiver



PA5522 Zing Supine TT Base
Comes with four swivel locking casters, foot operated gas spring, and a mast receiver.



PA5624, PA5626, PA5628 Multi-Adjustable Foot Plates
Foot plates are adjustable forward/aft +/- .75" (2cm) +extra 1.5" (3.8cm), plantar/dorsi +/- 20°, toe-in/toe-out, swivel 30° left/right, and in height. Foot holder sizes: PA5624-6"Lx3"W (15x8cm), PA5626-7.75"Lx3.25"W (20x8cm), PA5628-9.75"Lx4"W (25x10cm).



PA5666, PA5668, PA5670 Knee Strap
4"x6" (10x15cm) pad attached to a 1.5" (4cm) belt. Fits circumference up to 15" (38cm). Adjustable in height. For leg supports PA5644, PA5646, PA5648.



PA5632 Mast
Mast is the base for support and positioning components.



PA5540, PA5542, PA5544 Foot Holders
Use with the platform foot plate, gives added positioning of users feet. Foot holder sizes: PA5540-6"Lx3"W (15x8cm), PA5542-7.75"Lx3.25"W (20x8cm), PA5544-9.75"Lx4"W (25x10cm).



PA5556 Multi-Adjustable Knee Pads-4"Hx3.5"W
PA5558 Multi-Adjustable Knee Pads-4"Hx4"W
Multi-adjustable knee pads are adjustable in swivel, height +/- .75" (2cm), PA5556 width 4"-9" (10-23cm) and PA5558 4.5"-9" (11-23cm). With a depth range of 5" (13cm).



PA5634 Mast with Leg Abduction
Mast is the base for support and positioning components and allows for 0-30° of independent leg abduction. Multi-adjustable knee pads and multi-adjustable foot plates required to do leg abduction.



PA5546 Secure Foot Straps-8"L
PT50082 Secure Foot Straps-10"L
Velcro® and D-ring adjustment holds feet securely in place at ankles and toes with multiple attachment slots for proper foot positioning. Straps measured in length over top of foot, with approximately 1.5" (4cm) of Velcro® overlap.



PA5560, PA5678 Multi-Adjustable Calf Pads
Great for adapting to knee contractures. Gives support from the back of the calf. Adjustable up and down with knee pad and fore/aft -1"-4" (-2.5-10cm) independently. Must order multi-adjustable knee pads.



PA5612 Dual Control
Allows both foot and hand control of the gas spring lift. Must order push handle PA5594.



PA5548 Foot Straps-8"L
PT50080 Foot Straps-10"L
Velcro® and D-ring adjustment holds feet in alignment with multiple attachment slots for proper foot positioning. Straps measured in length over top of foot, with approximately 1.5" (4cm) of Velcro® overlap.

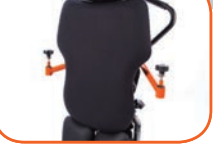

PA5638, PA5640, PA5642 Planar Pad
Cushioned pad covered with Neoprene®. Pad sizes: PA5638-14"Hx14"W (36x36cm) PA5640-16"Hx14"W (41x36cm) PA5642-18"Hx14"W (46x36cm)



PA5614 Gas Spring Lockout
Locks gas spring in any position from lying down to fully upright and supine positions.



PA5644, PA5646, PA5648 Leg Support Planar Pads
Cushioned Neoprene® pad for leg support. Pad sizes: PA5644-4"Hx6"W (10x15cm) PA5646-6"Hx6"W (15x15cm) PA5648-8"Hx6"W (20x15cm)

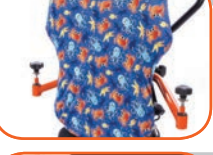

PA3063, PA3064, PA3065 Hygienic Covers
Washable slip on cover available in six different patterns. For planar pads PA5638, PA5640, PA5642.



PA5608 Directional Locking Caster
Great for transporting stander. Directionally locks one caster while leaving the other three free to swivel.



PA5660, PA5662, PA5664 Hygienic Covers
Washable slip on cover available in six different patterns. For planar pads PA5644, PA5646, PA5648.



PA5636 Hip Supports
Keeps the hips in symmetrical alignment. Adjustable from 6"-10" (15-25cm) with fore/aft 4" (10cm). Pad size is 3.5"x3.5" (9x9cm).



PA5536 Platform Foot Plate
Adjustable in height. Foot holders and foot straps can be added for more positioning of the feet.



PA5550 Calf/Knee Pad with Strap
4"x10" (10x25cm) pad attached to a 2" (5cm) belt with a D-Ring Velcro closure, provides calf/knee stability for user. Fits circumference up to 24" (61cm). Gives support from the back of the calf/knee. Adjustable in height and fore/aft.



PA3062 Positioning Strap
2" (5cm) wide belt has a D-Ring Velcro closure, provides hip stability for user. Fits circumference up to 24" (61cm).



PA5672 Pelvic Padded Positioning Strap
5"x8" (13x20cm) pad attached to a 2" (5cm) belt. Fits circumference up to 24" (61cm).



PA3066, PA3035, PA3036, PA3037 Hygienic Covers
Washable slip on cover available in six different patterns. For head supports PA5650, PY5626, PY5628, PA5586.



P80809 Tool Pouch
Holds the assembly tools provided with the stander. Attaches to unit with Velcro® straps.



PA5652 Lateral Supports-4"-8"Range
PA5654 Lateral Supports-7"-11"Range
Keeps the upper torso in symmetrical alignment. PA5652 Adjustable from 4"-8" (10-20cm), PA5654 Adjustable from 7"-11" (18-28cm) with a 3.5" (9cm) height range. Pad size is 3.5"Hx3.5"W (9x9cm).



PA5596 Black Molded Tray-11"Lx19"W
Tray is accessible in all positions and provides anterior support as user moves from supine to upright and prone positions. Adjustable in depth and height. Tray size is 11"Lx19"W (28x48cm).



P80246 Angle Locator
Helps therapists monitor standing progress. Attaches to the mast. Can be used on leg abduction.



PA5674 Upper Body Padded Positioning Strap
5"x8" (13x20cm) pad attached to a 2" (5cm) belt. Fits circumference up to 24" (61cm).



PA5600 Black Molded Swing-Away Tray-11"Lx19"W
Swing-away tray is accessible in all positions and provides anterior support as user moves from supine to upright and prone positions. Adjustable in depth, height and tray angle. Tray size is 11"Lx19"W (28x48cm).



PA5602 Clear Swing Away Tray-11"Lx19"W
Swing-away tray is accessible in all positions and provides anterior support as user moves from supine to upright and prone positions. Adjustable in depth, height and tray angle. Tray size is 11"Lx19"W (28x48cm).

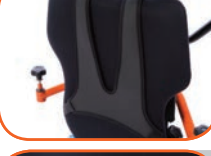

PT50086 X-Style Chest Vest-9.5"Lx9"W
PT50088 X-Style Chest Vest-11"Lx9.5"W
Neoprene® with camlock adjustment provides anterior trunk support for child.



PA5604 Forearm Wings-Black Molded Tray
Wings give additional area to rest arms when in standing position.



PA5606 Forearm Wings-Clear Acrylic Tray
Wings give additional area to rest arms when in standing position.

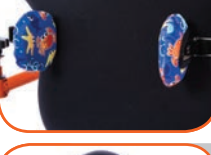

PA3039 Hygienic Covers for Lateral Supports
Washable slip on cover available in six different patterns. For lateral supports PA5652 and PA5654.



PA5650 Planar Head Support
Cushioned Neoprene® pad for head support. Pad size 8"Hx8.5"W (21x22cm).



PY5626 Head Support-5"Hx8"W
PY5628 Head Support-6"Hx10"W
Cushion size is 5"Hx8"W (13x20cm), 6"Hx10"W (15x25cm). Depth range is +1" to -2.75" (+2 to -7cm) from backrest. Maximum height from seat is 24" (61cm).

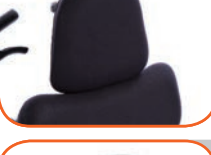

PA5650 Planar Head Support
Cushioned Neoprene® pad for head support. Pad size 8"Hx8.5"W (21x22cm).



PA3038 Hygienic Padded Tray Cover
Washable slip on cover for tray is padded and available in six different patterns.



PNG50042 Hand Grips
Provides additional arm and hand support and alignment. Easily movable for precise arm positioning. Attaches with suction cups. Clear tray required.



PA5586 Form to Fit Headrest
Cushion size 5"Hx10"W (13x25cm). Depth range is -2.5" (6cm) to +1.5" (4cm) from backrest. Maximum height from top of upper body pad is 8" (20cm).



PA5594 Push Handle
Makes pushing the stander easier for the caregiver and also aids in lifting and lowering the child. Required for dual control.



PA5676 Headrest Mounting Bracket
For use when mounting an after market head support.



PA5676 Headrest Mounting Bracket
For use when mounting an after market head support.



PA5594 Push Handle
Makes pushing the stander easier for the caregiver and also aids in lifting and lowering the child. Required for dual control.



PA5594 Push Handle
Makes pushing the stander easier for the caregiver and also aids in lifting and lowering the child. Required for dual control.



PA5676 Headrest Mounting Bracket
For use when mounting an after market head support.



PA5594 Push Handle
Makes pushing the stander easier for the caregiver and also aids in lifting and lowering the child. Required for dual control.



PA5594 Push Handle
Makes pushing the stander easier for the caregiver and also aids in lifting and lowering the child. Required for dual control.

Zing Vertical Options

up to 44"
(112cm)



70 lbs
(32 kg)

The Supine base includes:

- Four Swivel Locking Casters
- Mast Receiver

 <p>PA5524 Zing Vertical Base Comes with four swivel locking casters and a mast receiver.</p>	 <p>PA5546 Secure Foot Straps-8"L PT50082 Secure Foot Straps-10"L Velcro® and D-ring adjustment holds feet securely in place at ankles and toes with multiple attachment slots for proper foot positioning. Straps measured in length over top of foot, with approximately 1.5" (4cm) of Velcro® overlap.</p>	 <p>PA5574 Hip Supports Keeps the hips in symmetrical alignment. Adjustable from 6"-10" (15-25cm) with fore/aft 4" (10cm). Pad size is 3.5"x3.5" (9x9cm). For planar pads only.</p>
 <p>PA5530 Mast Mast is the base for support and positioning components.</p>	 <p>PA5548 Foot Straps-8"L PT50080 Foot Straps-10"L Velcro® and D-ring adjustment holds feet in alignment with multiple attachment slots for proper foot positioning. Straps measured in length over top of foot, with approximately 1.5" (4cm) of Velcro® overlap.</p>	 <p>PA3011 Positioning Strap 2" (5cm) wide belt has a D-Ring Velcro closure, provides hip stability for user. Fits circumference up to 24" (61cm).</p>
 <p>PA5532 Mast with Leg Abduction Mast is the base for support and positioning components and allows for 0-30° of independent leg abduction. Multi-adjustable knee pads and multi-adjustable foot plates required to do leg abduction.</p>	 <p>PA5550 Calf/Knee Pad with Strap 4"x10" (10x25cm) pad attached to a 2" (5cm) belt with a D-Ring Velcro closure, provides calf/knee stability for user. Fits circumference up to 24" (61cm). Gives support from the back of the calf/knee. Adjustable in height and fore/aft.</p>	 <p>PA5610 Padded Positioning Strap 5"x8" (13x20cm) pad attached to a 2" (5cm) belt. Fits circumference up to 24" (61cm).</p>
 <p>PA5608 Directional Locking Caster Great for transporting stander. Directionally locks one caster while leaving the other three free to swivel.</p>	 <p>PA5688 Multi-Adjustable Knee Pads-4"Hx3.5"W PA5690 Multi-Adjustable Knee Pads-4"Hx4"W Multi-adjustable knee pads are adjustable in swivel, height +/- .75" (2cm), PA5688 width 4"-9" (10-23cm) and PA5690 4.5"-9" (11-23cm). With a depth range of 5" (13cm).</p>	 <p>PA3092 Quick Strap 2" (5cm) wide belt has a airline style buckle for quick closure, provides hip stability for user. Fits circumference up to 24" (61cm).</p>
 <p>PA5680 Platform Foot Plate Adjustable in height. Foot holders and foot straps can be added for more positioning of the feet.</p>	 <p>PA5726 Knee Strap 4"x6" (10x15cm) pad attached to a 1.5" (4cm) belt. Fits circumference up to 15" (38cm). Adjustable in height. For PA5688 and PA5690.</p>	 <p>PA3093 Padded Quick Strap 5"x8" (13x20cm) pad attached to a 2" (5cm) belt has a airline style buckle for quick closure. Fits circumference up to 24" (61cm).</p>
 <p>PA5624, PA5626, PA5628 Multi-Adjustable Foot Plates Foot plates are adjustable forward/aft +/- .75" (2cm) +extra 1.5" (3.8cm), plantar/dorsi +/- 20°, toe-in/toe-out, swivel 30° left/right, and in height. Foot holder sizes: PA5624-6"Lx3"W (15x8cm), PA5626-7.75"Lx3.25"W (20x8cm), PA5628-9.75"Lx4"W (25x10cm).</p>	 <p>PA5562, PA5564, PA5616, PA5618 Planar Pad Cushioned pad covered with Neoprene®. Pad sizes: PA5562-5"Lx7"W (13x18cm) PA5564-5"Lx9"W (13x21cm) PA5616-7"Lx7"W (18x18cm) PA5618-7"Lx9"W (18x21cm)</p>	 <p>PA3028, PA3029, PA3045, PA3046 Hygienic Cover Washable slip on cover available in six different patterns. For planar pads PA5562, PA5564, PA5616, PA5618.</p>
 <p>PA5540, PA5542, PA5544 Foot Holders Use with the platform foot plate, gives added positioning of users feet. Foot holder sizes: PA5540-6"Lx3"W (15x8cm), PA5542-7.75"Lx3.25"W (20x8cm), PA5544-9.75"Lx4"W (25x10cm).</p>	 <p>PA5566 Form to Fit Pads-5"Hx10"W PA5570 Form to Fit Pads-5"Hx12"W Form to fit pad can be custom fitted to the user. Pad sizes: PA5566-5"Hx10" (13x25cm) PA5570-5"Hx12"W (13x30cm).</p>	 <p>PA3030, PA3032 Hygienic Cover Washable slip on cover available in six different patterns. For form to fit pads PA5566 and PA5570.</p>

 <p>PA5692, PA5562, PA5564, PA5616, PA5618 Planar Pad Cushioned pad covered with Neoprene®. Pad sizes: PA5692-5"Hx5"W (13x13cm) PA5562-5"Hx7"W (13x18cm) PA5564-5"Hx9"W (13x21cm) PA5616-7"Hx7"W (18x18cm) PA5618-7"Hx9"W (18x21cm)</p>	 <p>PA3085, PA3086, PA3087, PA3088 Hygienic Cover Washable slip on cover available in six different patterns. For form to fit pads PA5694, PA5696, PA5698 and PA5700.</p>	 <p>PNG50042 Hand Grips Provides additional arm and hand support and alignment. Easily movable for precise arm positioning. Attaches with suction cups. Clear tray required.</p>
 <p>PA5566 Form to Fit Pads-5"Hx10"W PA5570 Form to Fit Pads-5"Hx12"W Form to fit pad with built in lateral support that can be custom fitted to the user. Pad sizes are: PA5566-5"Hx10"W (13x25cm), PA5570-5"Hx12"W (13x30cm).</p>	 <p>PA5706 Face Aperture-5"H PA5708 Face Aperture-7"H Pad size is 9"Hx3"W (23x8cm). With a 5" (13cm) or 7" (18cm) range from the upper body support, individual face aperture pads are adjustable. Supports the head.</p>	 <p>PA5720 Push Handle for Tray Makes pushing the stander easier for the caregiver.</p>
 <p>PA5694 Form to Fit Pads-5"Hx10"W PA5696 Form to Fit Pads-5"Hx12"W Form to fit pad with extra sternum positioning. Built in lateral support that can be custom fitted to the user. Pad sizes are: PA5694-5"Hx10"W (13x25cm), PA5696-5"Hx12"W (13x30cm).</p>	 <p>PA5710 Hygienic Cover Washable slip on cover available in six different patterns. For face apertures PA5706 and PA5708.</p>	 <p>P80809 Tool Pouch Holds the assembly tools provided with the stander. Attaches to unit with Velcro® straps.</p>
 <p>PA5698 Form to Fit Pads-7"Hx10"W PA5700 Form to Fit Pads-7"Hx12"W Form to fit pad with extra sternum positioning. Built in lateral support that can be custom fitted to the user. Pad sizes are: PA5698-7"Hx10"W (18x25cm), PA5700-7"Hx12"W (18x30cm).</p>	 <p>PA5712 Black Molded Tray-11"Lx19"W Tray provides anterior support. Adjustable in depth and height. Tray size is 11"Lx19"W (28x48cm).</p>	 <p>P80246 Angle Locator Helps therapists monitor standing progress. Attaches to the mast. Can be used on leg abduction.</p>
 <p>PA5702 Lateral Supports-4"-8" Range PA5704 Lateral Supports-7"-11" Range Keeps the upper torso in symmetrical alignment. PA5702 Adjustable from 4"-8" (10-20cm), PA5704 Adjustable from 7"-11" (18-28cm) with a 3.5" (9cm) height range. Pad size is 3.5"Hx3.5"W (9x9cm). For planar pads only.</p>	 <p>PA5716 Multi-Adjustable Black Molded Tray-11"Lx19"W Tray provides anterior support. Adjustable in depth, height and tray angle. Tray size is 11"Lx19"W (28x48cm).</p>	
 <p>PA5610 Padded Positioning Strap 5"x8" (13x20cm) pad attached to a 2" (5cm) belt. Fits circumference up to 24" (61cm).</p>	 <p>PA5718 Multi-Adjustable Clear Tray-11"Lx19"W Tray provides anterior support. Adjustable in depth, height and tray angle. Tray size is 11"Lx19"W (28x48cm).</p>	
 <p>PA3039 Hygienic Covers for Lateral Supports Washable slip on cover available in six different patterns. For lateral supports PA5702 and PA5704.</p>	 <p>PA5604 Forearm Wings-Black Molded Tray Wings give additional area to rest arms when in standing position.</p>	
 <p>PA3084, PA3028, PA3029, PA3045, PA3046 Hygienic Cover Washable slip on cover available in six different patterns. For planar pads PA5692, PA5562, PA5564, PA5616, and PA5618.</p>	 <p>PA5606 Forearm Wings-Clear Acrylic Tray Wings give additional area to rest arms when in standing position.</p>	
 <p>PA3030, PA3032 Hygienic Cover Washable slip on cover available in six different patterns. For form to fit pads PA5566 and PA5570.</p>	 <p>PA3038 Hygienic Padded Cover Washable slip on cover for tray is padded and available in six different patterns.</p>	

Zing Prone Options

up to 44"
(112cm)



The Supine base includes:

- Four Swivel Locking Casters
- Foot Operated Gas Spring
- Mast Receiver



PA5522 Zing Prone Base
Comes with four swivel locking casters, foot operated gas spring, and a mast receiver.



PA5624, PA5626, PA5628 Multi-Adjustable Foot Plates
Foot plates are adjustable forward/aft +/- .75" (2cm) +extra 1.5" (3.8cm), plantar/dorsi +/- 20°, toe-in/toe-out, swivel 30° left/right, and in height. Foot holder sizes: PA5624-6"Lx3"W (15x8cm), PA5626-7.75"Lx3.25"W (20x8cm), PA5628-9.75"Lx4"W (25x10cm).



PA5562, PA5564, PA5616, PA5618 Planar Pad
Cushioned pad covered with Neoprene®. Pad sizes:
PA5562-5"Lx7"W (13x18cm)
PA5564-5"Lx9"W (13x21cm)
PA5616-7"Lx7"W (18x18cm)
PA5618-7"Lx9"W (18x21cm)



PA5530 Mast
Mast is the base for support and positioning components.



PA5540, PA5542, PA5544 Foot Holders
Use with the platform foot plate, gives added positioning of users feet. Foot holder sizes: PA5540-6"Lx3"W (15x8cm), PA5542-7.75"Lx3.25"W (20x8cm), PA5544-9.75"Lx4"W (25x10cm).



PA5566 Form to Fit Pads-5"Hx10"W
PA5570 Form to Fit Pads-5"Hx12"W
Form to fit pad can be custom fitted to the user. Pad sizes: PA5566-5"Hx10" (13x25cm) PA5570-5"Hx12"W (13x30cm).



PA5532 Mast with Leg Abduction
Mast is the base for support and positioning components and allows for 0-30° of independent leg abduction. Multi-adjustable knee pads and multi-adjustable foot plates required to do leg abduction.



PA5546 Secure Foot Straps-8"L
PT50082 Secure Foot Straps-10"L
Velcro® and D-ring adjustment holds feet securely in place at ankles and toes with multiple attachment slots for proper foot positioning. Straps measured in length over top of foot, with approximately 1.5" (4cm) of Velcro® overlap.

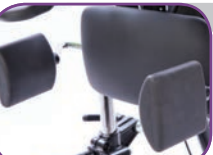

PA5574 Hip Supports
Keeps the hips in symmetrical alignment. Adjustable from 6"-10" (15-25cm) with fore/aft 4" (10cm). Pad size is 3.5"x3.5" (9x9cm). For planar pads only.



PA5725 Dual Control
Allows both foot and hand control of the gas spring lift. Must order push handle PA5720.



PA5548 Foot Straps-8"L
PT50080 Foot Straps-10"L
Velcro® and D-ring adjustment holds feet in alignment with multiple attachment slots for proper foot positioning. Straps measured in length over top of foot, with approximately 1.5" (4cm) of Velcro® overlap.



PA3011 Positioning Strap
2" (5cm) wide belt has a D-Ring Velcro closure, provides hip stability for user. Fits circumference up to 24" (61cm).



PA5614 Gas Spring Lift Lockout
Locks gas spring in any position from lying down to fully upright and supine positions.



PA5550 Calf/Knee Pad with Strap
4"x10" (10x25cm) pad attached to a 2" (5cm) belt with a D-Ring Velcro closure, provides calf/knee stability for user. Fits circumference up to 24" (61cm). Gives support from the back of the calf/knee. Adjustable in height and fore/aft.



PA5610 Padded Positioning Strap
5"x8" (13x20cm) pad attached to a 2" (5cm) belt. Fits circumference up to 24" (61cm).



PA5608 Directional Locking Caster
Great for transporting stander. Directionally locks one caster while leaving the other three free to swivel.



PA5688 Multi-Adjustable Knee Pads-4"Hx3.5"W
PA5690 Multi-Adjustable Knee Pads-4"Hx4"W
Multi-adjustable knee pads are adjustable in swivel, height +/- .75" (2cm), PA5688 width 4"-9" (10-23cm) and PA5690 4.5"-9" (11-23cm). With a depth range of 5" (13cm).



PA3092 Quick Strap
2" (5cm) wide belt has a airline style buckle for quick closure, provides hip stability for user. Fits circumference up to 24" (61cm).



PA5680 Platform Foot Plate
Adjustable in height. Foot holders and foot straps can be added for more positioning of the feet.



PA5726 Knee Strap
4"x6" (10x15cm) pad attached to a 1.5" (4cm) belt. Fits circumference up to 15" (38cm). Adjustable in height. For PA5688 and PA5690.



PA3093 Padded Quick Strap
5"x8" (13x20cm) pad attached to a 2" (5cm) belt has a airline style buckle for quick closure. Fits circumference up to 24" (61cm).



PA3028, PA3029, PA3045, PA3046 Hygienic Cover
Washable slip on cover available in six different patterns. For planar pads PA5562, PA5564, PA5616, PA5618.



PA3084, PA3028, PA3029, PA3045, PA3046 Hygienic Cover
Washable slip on cover available in six different patterns. For planar pads PA5692, PA5562, PA5564, PA5616, and PA5618.



PA5606 Forearm Wings-Clear Acrylic Tray
Wings give additional area to rest arms when in standing position.



PA3030, PA3032 Hygienic Cover
Washable slip on cover available in six different patterns. For form to fit pads PA5566 and PA5570.



PA3030, PA3032 Hygienic Cover
Washable slip on cover available in six different patterns. For form to fit pads PA5566 and PA5570.



PA3038 Hygienic Padded Cover
Washable slip on cover for tray is padded and available in six different patterns.



PA5692, PA5562, PA5564, PA5616, PA5618 Planar Pad
Cushioned pad covered with Neoprene®. Pad sizes:
PA5692-5"Hx5"W (13x13cm)
PA5562-5"Hx7"W (13x18cm)
PA5564-5"Hx9"W (13x21cm)
PA5616-7"Hx7"W (18x18cm)
PA5618-7"Hx9"W (18x21cm)



PA3085, PA3086, PA3087, PA3088 Hygienic Cover
Washable slip on cover available in six different patterns. For form to fit pads PA5694, PA5696, PA5698 and PA5700.



PNG50042 Hand Grips
Provides additional arm and hand support and alignment. Easily movable for precise arm positioning. Attaches with suction cups.



PA5566 Form to Fit Pads-5"Hx10"W
PA5570 Form to Fit Pads-5"Hx12"W
Form to fit pad with extra sternum positioning. Built in lateral support that can be custom fitted to the user. Pad sizes are: PA5566-5"Hx10"W (13x25cm), PA5570-5"Hx12"W (13x30cm).



PA5706 Face Aperture-5"H
PA5708 Face Aperture-7"H
Pad size is 9"Hx3"W (23x8cm). With a 5" (13cm) or 7" (18cm) range from the upper body support, individual face aperture pads are adjustable. Supports the head.



PA5720 Push Handle for Tray
Makes pushing the stander easier for the caregiver and also aids in lifting and lowering the child. Required for dual control.



PA5694 Form to Fit Pads-5"Hx10"W
PA5696 Form to Fit Pads-5"Hx12"W
Form to fit pad with extra sternum positioning. Built in lateral support that can be custom fitted to the user. Pad sizes are: PA5694-5"Hx10"W (13x25cm), PA5696-5"Hx12"W (13x30cm).

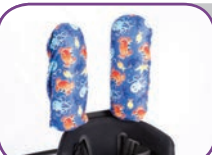

PA5710 Hygienic Cover
Washable slip on cover available in six different patterns. For face apertures PA5706 and PA5708.



P80809 Tool Pouch
Holds the assembly tools provided with the stander. Attaches to unit with Velcro® straps.



PA5698 Form to Fit Pads-7"Hx10"W
PA5700 Form to Fit Pads-7"Hx12"W
Form to fit pad with extra sternum positioning. Built in lateral support that can be custom fitted to the user. Pad sizes are: PA5698-7"Hx10"W (18x25cm), PA5700-7"Hx12"W (18x30cm).



PA5712 Black Molded Tray-11"Lx19"W
Tray provides anterior support. Adjustable in depth and height. Tray size is 11"Lx19"W (28x48cm).



P80246 Angle Locator
Helps therapists monitor standing progress. Attaches to the mast. Can be used on leg abduction.



PA5702 Lateral Supports-4"-8"Range
PA5704 Lateral Supports-7"-11"Range
Keeps the upper torso in symmetrical alignment. PA5702 Adjustable from 4"-8" (10-20cm), PA5704 Adjustable from 7"-11" (18-28cm) with a 3.5" (9cm) height range. Pad size is 3.5"Hx3.5"W (9x9cm). For planar pads only.



PA5716 Multi-Adjustable Black Molded Tray-11"Lx19"W
Tray provides anterior support. Adjustable in depth, height and tray angle. Tray size is 11"Lx19"W (28x48cm).



PA5610 Padded Positioning Strap
5"x8" (13x20cm) pad attached to a 2" (5cm) belt. Fits circumference up to 24" (61cm).



PA5718 Multi-Adjustable Clear Tray-11"Lx19"W
Tray provides anterior support. Adjustable in depth, height and tray angle. Tray size is 11"Lx19"W (28x48cm).

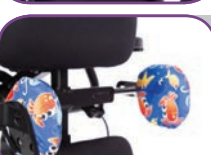

PA3039 Hygienic Covers for Lateral Supports
Washable slip on cover available in six different patterns. For lateral supports PA5702 and PA5704.



PA5604 Forearm Wings-Black Molded Tray
Wings give additional area to rest arms when in standing position.



EasyStand

Altimate Medical, Inc.
262 West First Street
Morton, MN 56270 USA
Tel: 800.342.8968 • 507.697.6393
Fax: 877.342.8968 • 507.697.6900
info@easystand.com • easystand.com